

Article number: 2082264M81B

Description: E+G Mini indexing plunger
with/without rest position, GN 822.6-4-M8x1-B

Measures

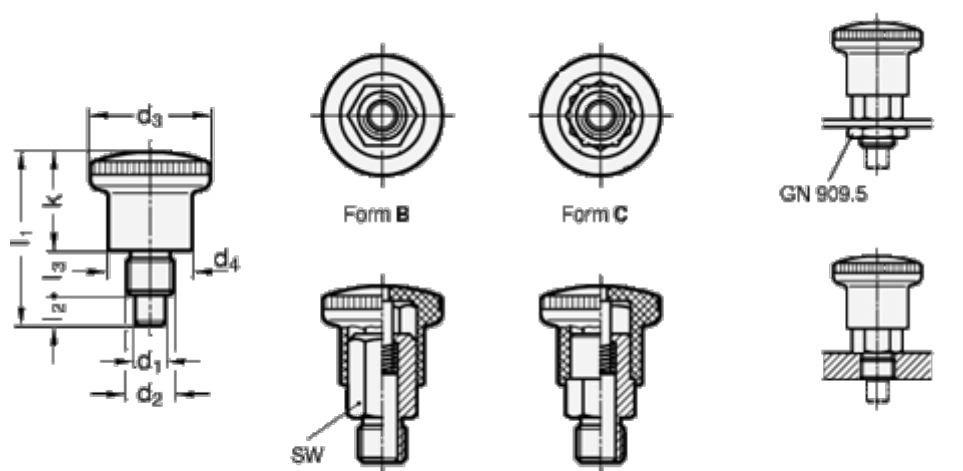

$d_1 = 4$

$d_2 = M8x1$

$d_3 = 21$

$d_4 = 15$

$k = 16.5$

$l_1 = 27.5$

$l_2 = 5$

$l_3 = 6$

Spring load initial $N = 4$